

High voltage flameproof induction motors
The simplest solution for explosive
atmospheres

We provide motors, generators and mechanical power transmission products, services and expertise to save energy and improve customers' processes over the total life cycle of our products, and beyond.





ABB high voltage flameproof motors deliver clear benefits

ABB's comprehensive research and development program offers the latest technological advantages in motors and drives – providing significant benefits for customers.

ABB designs and manufactures electric motors and drives, with over 100 years of experience in supplying high voltage AC motors for virtually all industries, including applications for explosive atmospheres.

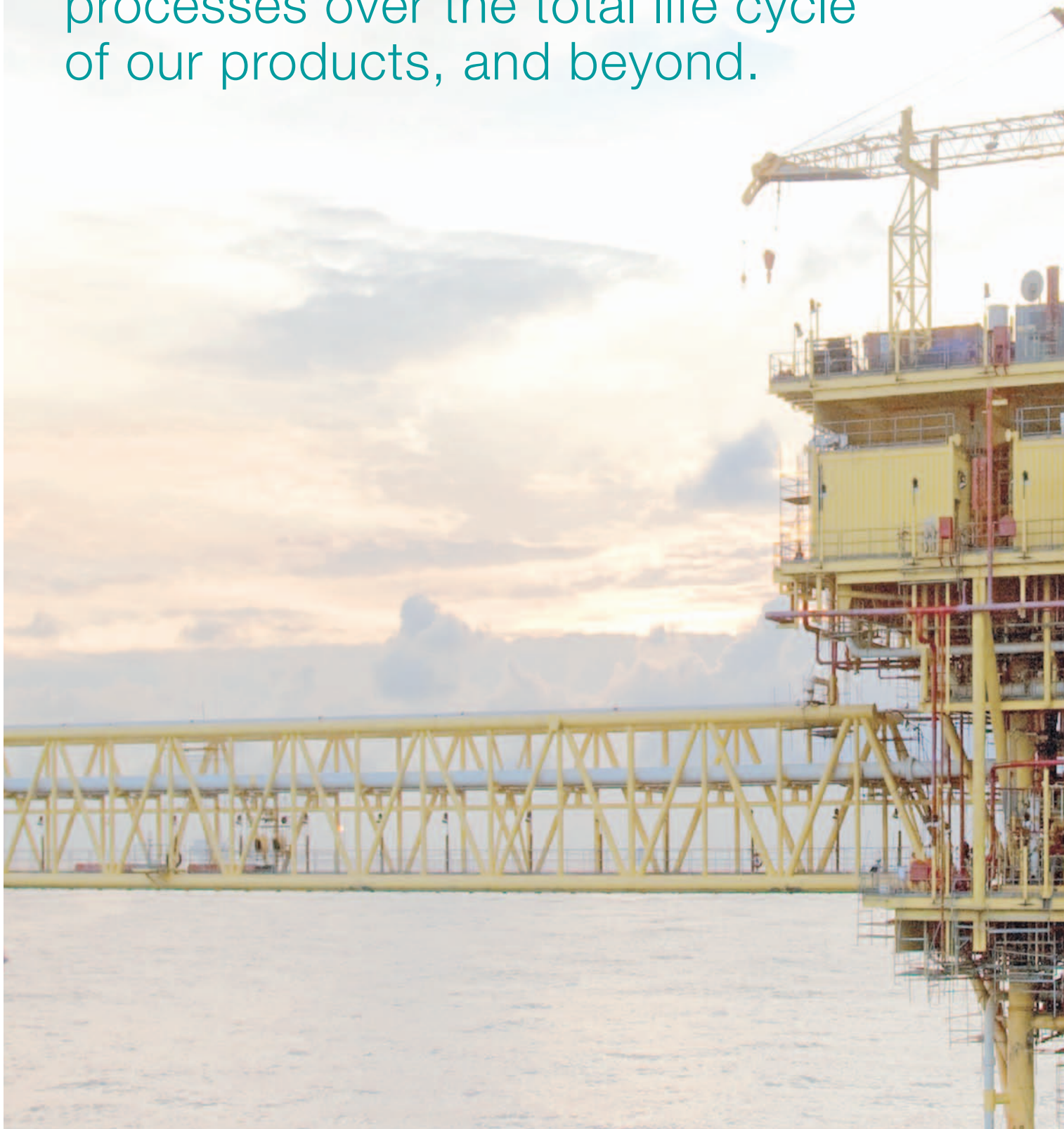
Features of flameproof protection:

- No purging before starting
- No pressurization system required
- No inert gas needed
- No thermal limitation for “t_e” time
- Low maintenance costs

ABB premium quality:

- High efficiency
- Low noise
- Long lifetime
- VPI insulation system
- Advanced design and latest technologies
- Over 100 years experience in rotating machines
- 50 years experience in manufacturing flameproof motors
- Global ABB service network
- ISO 9001 quality system
- ISO 14001 environmental management system

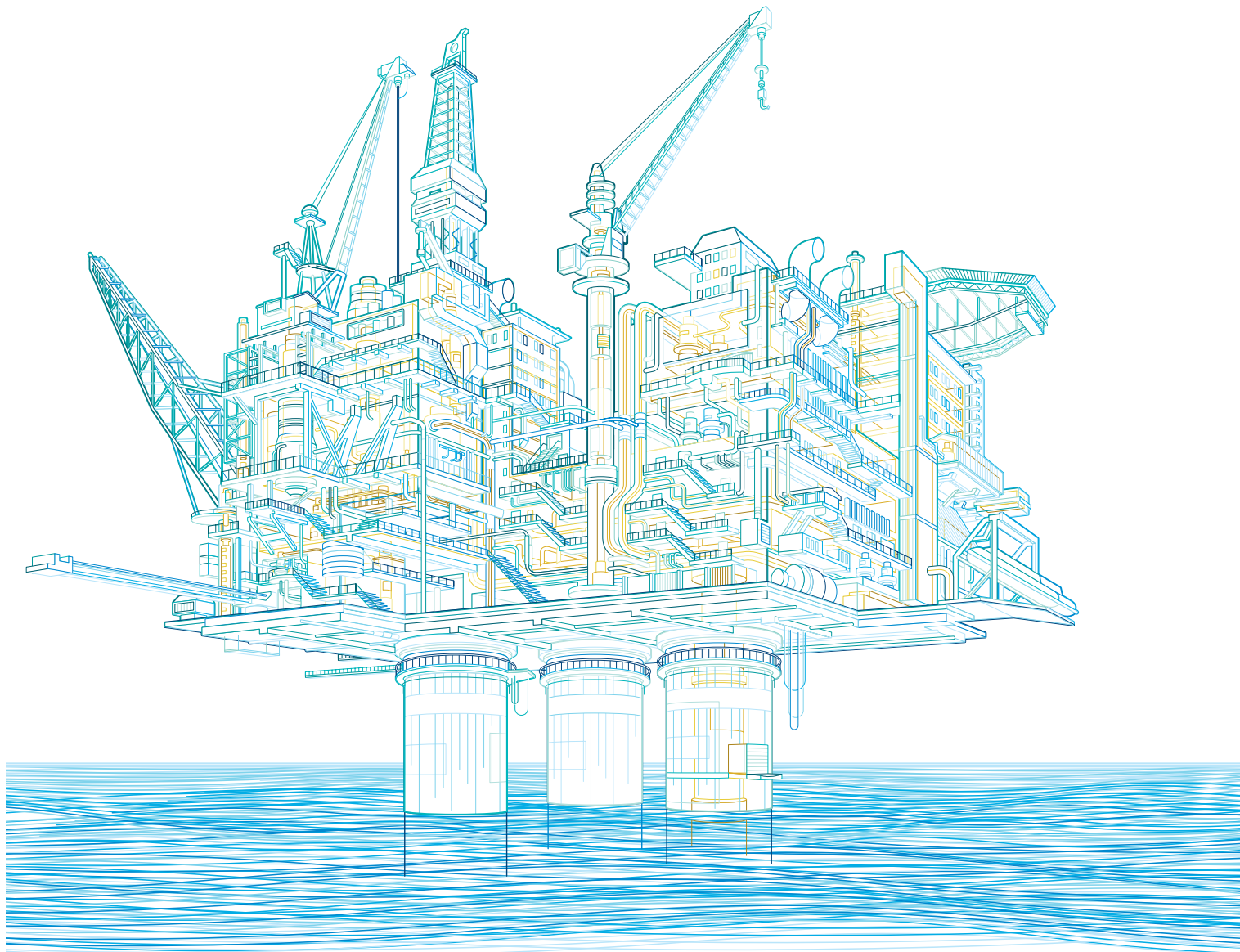

Compliance with major standards worldwide

ABB high voltage flameproof motors are designed and manufactured according to European (EN) and International (IEC) standards.

- EN / IEC 60079-0 General requirements
- EN / IEC 60079-1 Flameproof enclosures "d"
- ATEX 94/9/EC European Directive on equipment for use in potentially explosive atmospheres
- IECEx Scheme

ABB high voltage flameproof motors are certified by a Notified Body which is officially recognized worldwide. All prototypes have been successfully type tested and assigned a conformity certification number.

The Notified Body has certified that the manufacturing plant has product quality system which complies the requirements of the European Directive 94/9/EC (ATEX) for the production of motors for explosive atmospheres.

Standard certifications are:

Gas Group IIB and IIC T4 for IC411 and IC511.
Motors for T5 temperature class are available on request.



Typical national certifications:

Gas Group IIB and IIC T4 for IC411 and IC511 motors.
Motors for T5 temperature class are available on request.
The motors have been certified by the CSA. They comply with CSA and UL standards for electrical equipment for use in Class I, Zone 1 and 2.

The motors also comply with the Russian GOST Standard (ГОСТ P 52350.0 ГОСТ P 52350.1) and can be installed in areas where these standards are mandatory.

Other local certifications are available on request.



Reliable performance

High voltage flameproof motors for explosive atmospheres available in IEC or NEMA designs

Standard range

- Totally enclosed, fan cooled
- Designed for LV and HV supply
- Shaft heights 355-900 mm
- Horizontal and vertical applications
- IP55 as standard (higher on request)
- Cooling methods: IC411 and IC511
- Standards: EN, IEC, BS, ANSI, NEMA, IEEE, VDE, CSA, UL, GOST
- Suitable for variable speed drives
- Both 50 and 60 Hz available

AMD Output at 6000 V 50 Hz

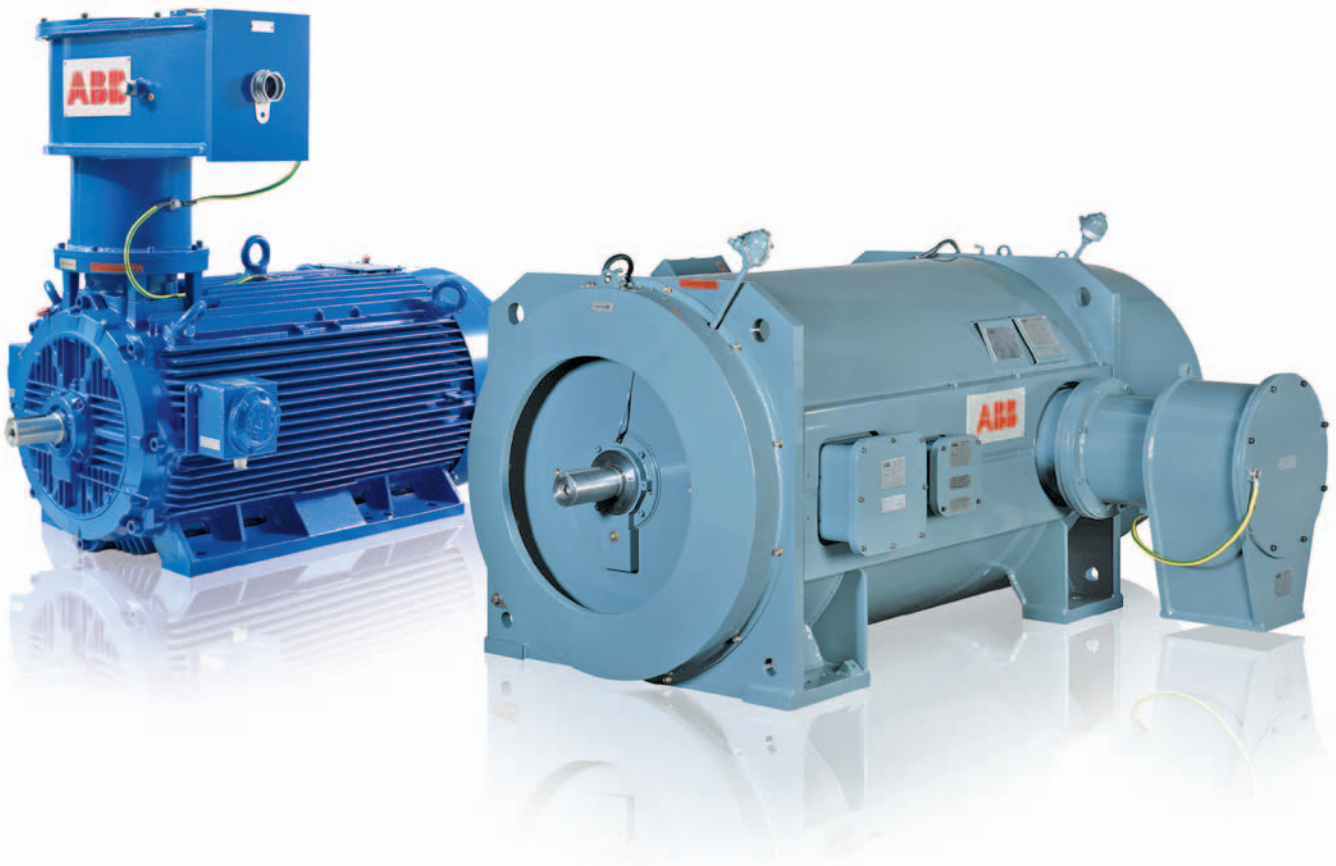
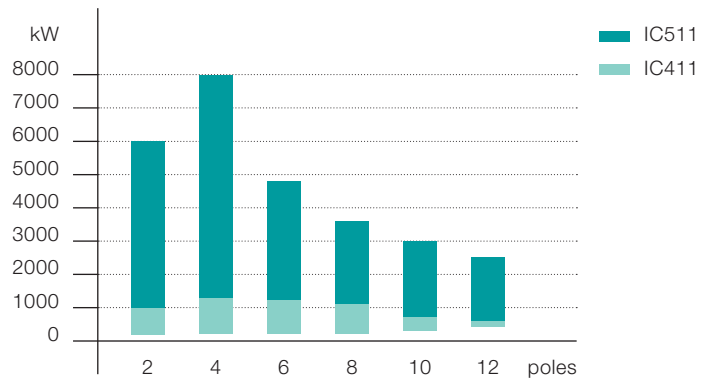



Cooling methods

AMD motors are available with different cooling methods:

- IC411 according to IEC 60034-6 with ribs all around the frame for the lower power range;
- IC511 according to IEC 60034-6 with air-to-air cooler fitted near the stator active parts inside the frame for the upper power range.

In both above cases motors are equipped with an external fan mounted on the shaft (NDE side).

- IC416 and IC516 according to IEC 60034-6 with forced external air ventilation by independent motor driven fan.

1 IC411 | 2 IC511 | 3 IC416 | 4 IC516

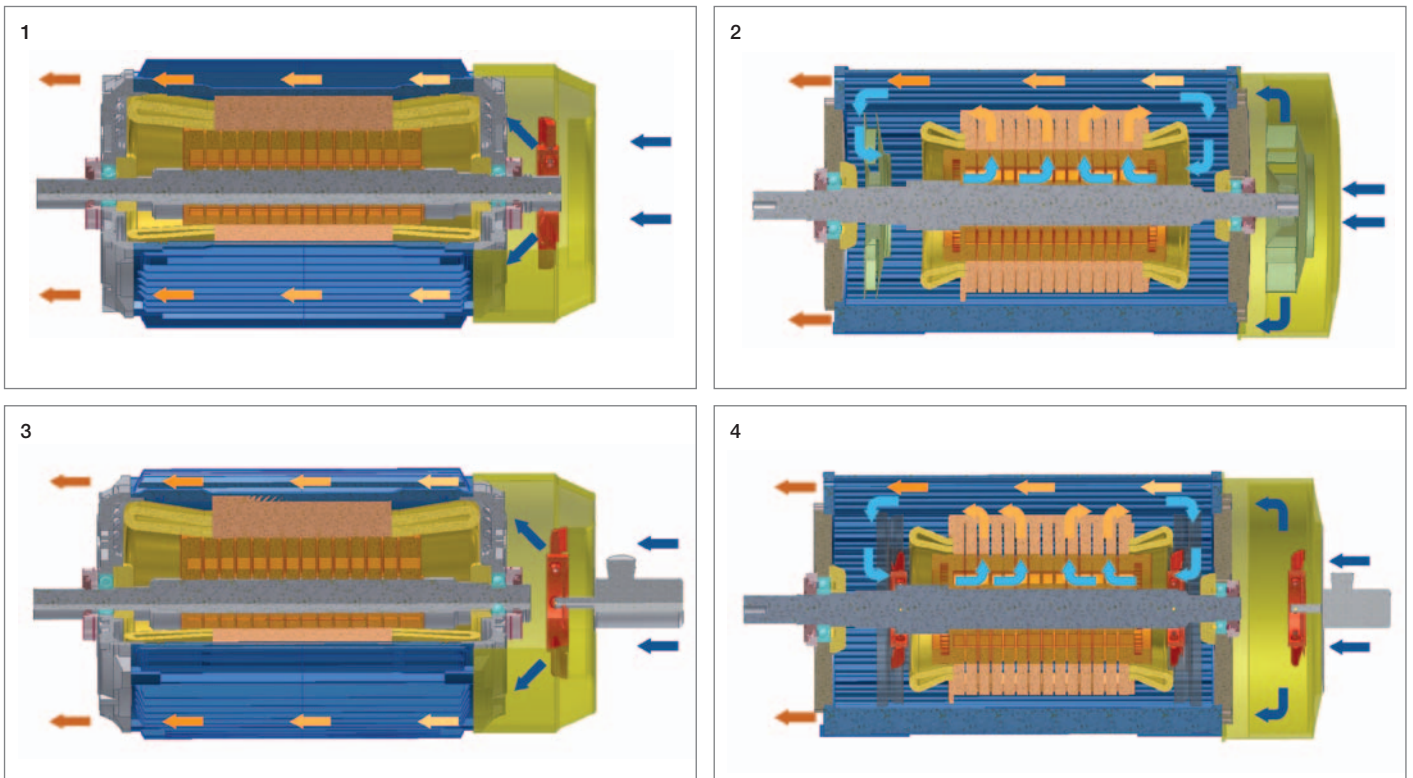



The rotor

The key to long life for the rotor lies in ensuring very low vibration levels. This is achieved through robust construction and careful balancing of each completed unit.

Rotor shaft material is selected according to the duty and the ambient conditions. The spider beam welds and subsequent stress relieving are performed according to rigorous norms and subjected to stringent inspection.

Squirrel cages are made from copper or copper alloy dependent upon the loading and individual customer requirements. Rotor bars are tightened to provide additional stiffness, enabling the motors to withstand long periods of heavy use.

The stator

The stator core is welded and machined to form a compact unit. Radial air ducts ensure uniform and efficient cooling.

The stator core forms a solid block that retains its rigidity throughout the life of the motor. The complete stator is vacuum pressure impregnated.

1 Micadur® Compact Industry Insulation System – ABB’s world renowned insulation system gives reliability and long life. The windings and connections are insulated with Mica based tape. When the windings are in place the whole stator is impregnated in the vacuum pressure impregnation (VPI) process. Class F is standard. | 2 Coil locking – proven methods for locking coils into slots and bracing coil ends ensure long term reliability. | 3 Special accessories for vibration monitoring | 4 and 5 Rotors | 6 Stator

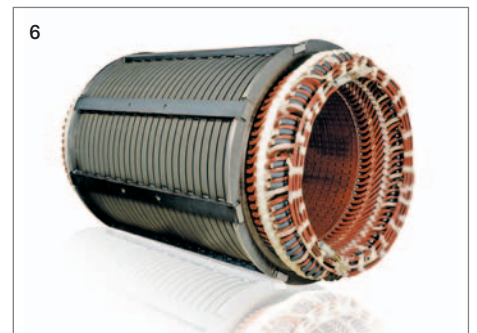
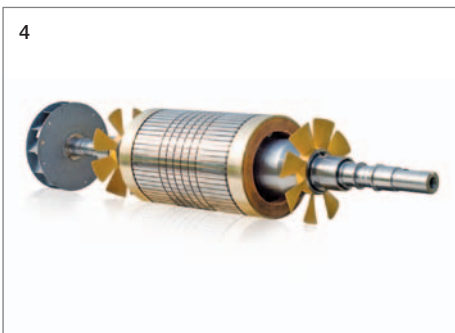
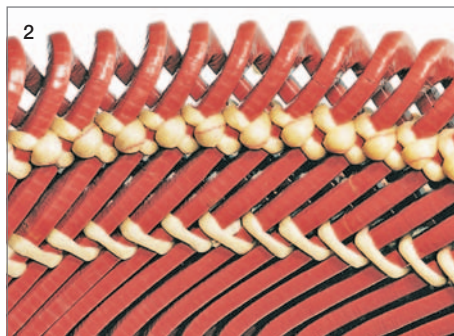

Performance and reliability start here

The frame

The compact, rigid, welded frame construction is designed to reduce overall weight, provide high lateral and torsional stability and ensure low vibration levels in all operating conditions and over the whole speed range.

The bearings

The bearings are designed for reliable, continuous operation and ease of maintenance. The right bearings are chosen based on the power and speed of the motor. Antifriction bearings with a predicted service life of over 100,000 hours can be specified. ABB also offers spherically seated, selfaligning sleeve bearings. For greater radial load capacity, cylindrical roller bearings can be used at the drive end with a deep-groove ball bearing at the non-drive end. All bearings feature a sealing system that prevents dust penetration.

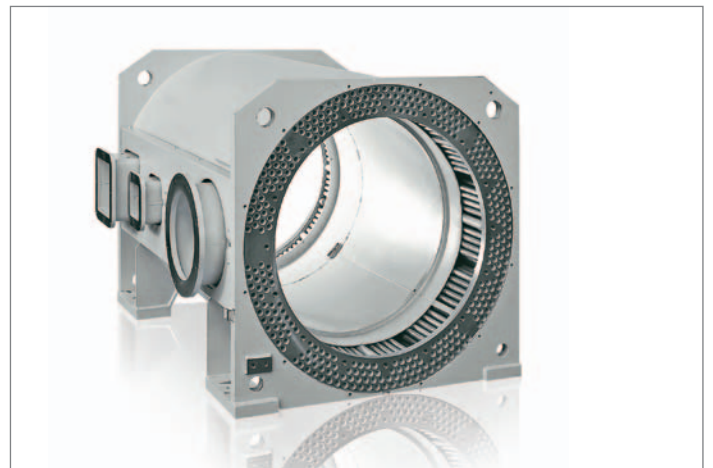

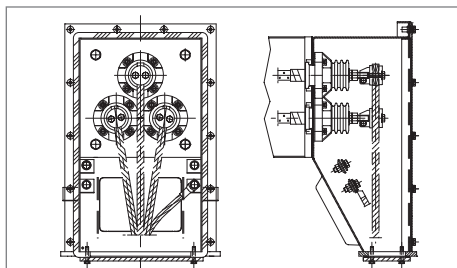
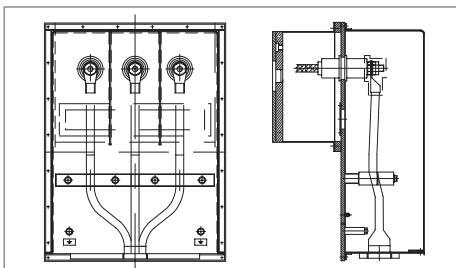
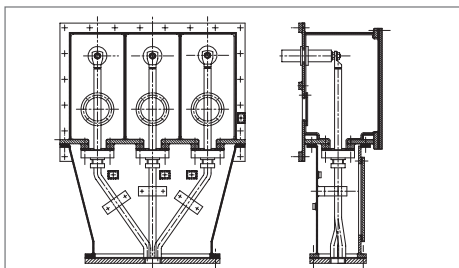
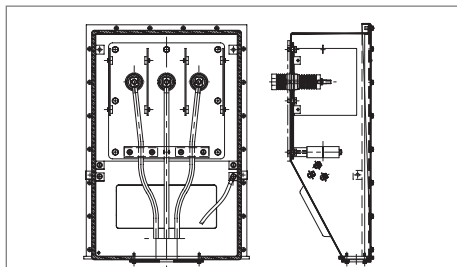
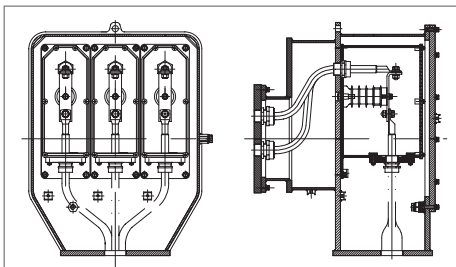
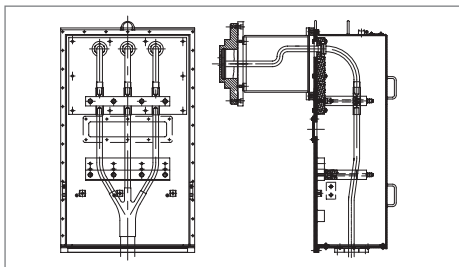
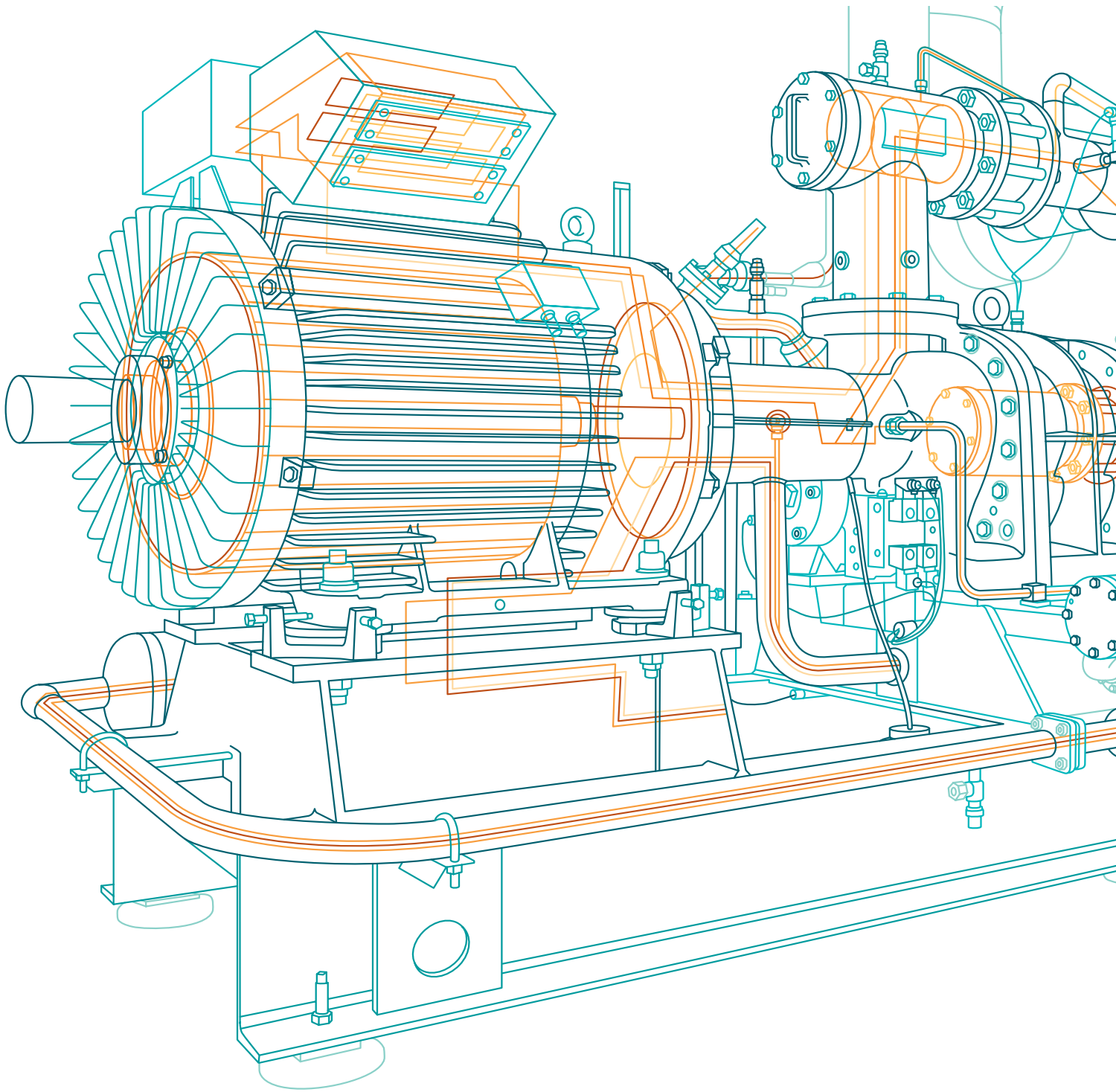

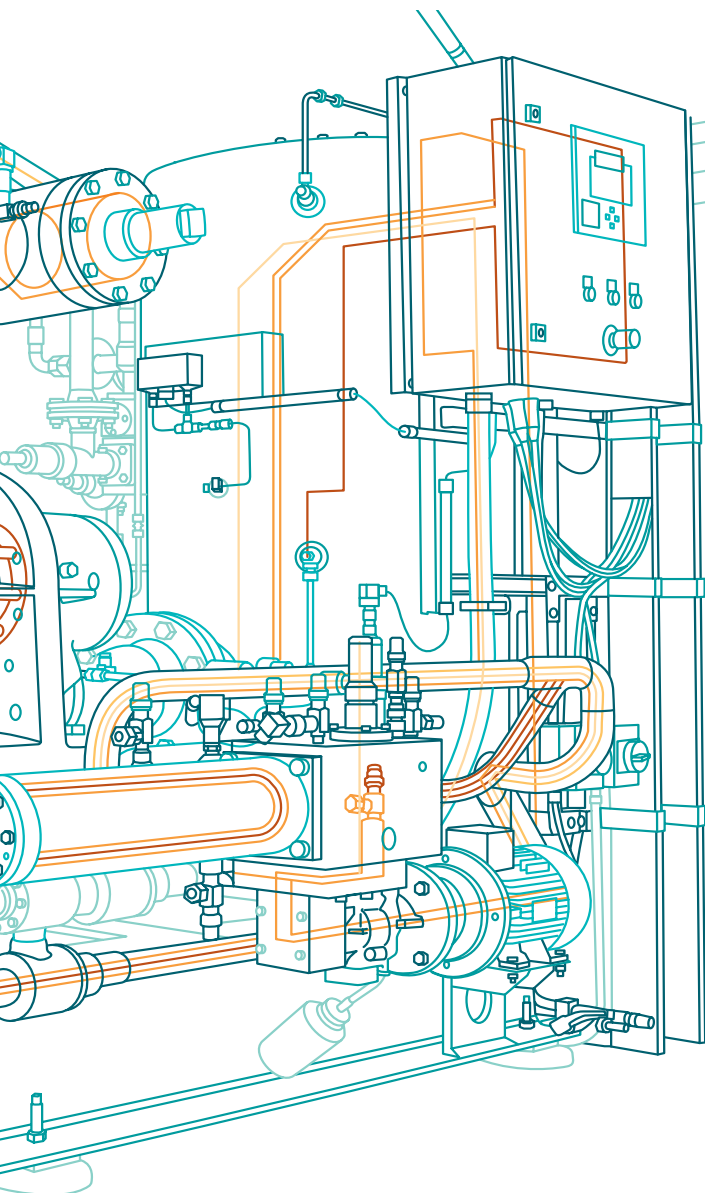

Easy-to-connect terminal boxes

The standard terminal box is available in Ex d 'flameproof' or Ex e 'increased safety' execution.

Other types of connection boxes can be provided on request (Ex e execution certified).

Following types are available:

- Phase separated
- Phase segregated
- Phase insulated

Different types of cable connection can be supplied on request, such as Raychem® termination or Elastimold®. The box is turnable by 90° to provide cable entry from any direction.

The terminal boxes are generously dimensioned in order to allow cable fitting.

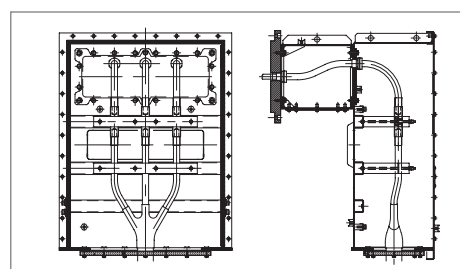
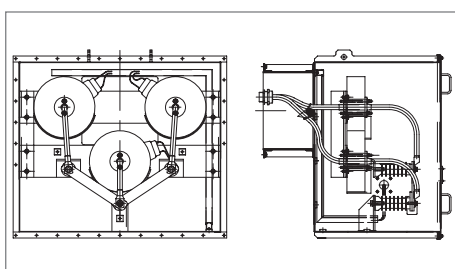
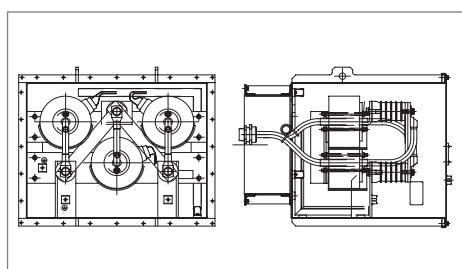
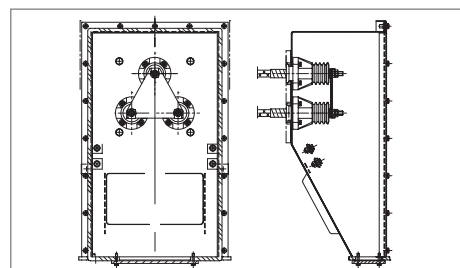
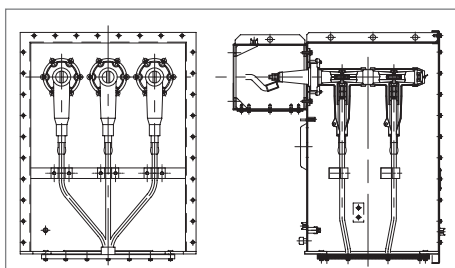
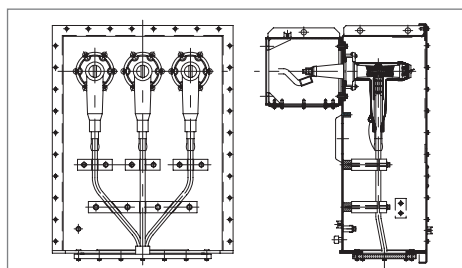

Motors with the right type of protection must be used in all explosive atmospheres to ensure safety

Motors with the right type of protection must be used in all explosive atmospheres to ensure safety

According to European Directive 94/9/EC (ATEX), IEC 60079.10, EN 60079.10 and NEC 505, hazardous environments are classified into Zones according to the probability that flammable substances will be present.

ABB high voltage flameproof motors are suitable for use in both Zones 1 and 2

- ZONE 0 (*)**
Continuous presence
- ZONE 1**
Presence during normal operation
- ZONE 2**
Presence only in case of failure or abnormal operation



(*) In ZONE 0 no electrical machine can be installed

Gas groups





Apparatus for use in explosive atmospheres can be classified in two groups (table Group I and II).

Air mixtures, gases and vapors are grouped as a function of the highest possible explosion pressure.

Group II apparatus is divided into sub-groups depending on the gas type (table Gas groups).

Group	Suitable for
I	Apparatus for coal mines
II	Apparatus for applications other than mines
Group	Typical Gas
IIA	Propane
IIB	Ethylene
IIC	Acetylene, Hydrogen (**)

(**) According to NEC505, Hydrogen can be classified as Group IIB + H2

Ex... type of protection	Suitable for	Main features
 Ex-p (IEC 60079-2)	Zones 1-2	The motor is continuously filled with protective gas so that the explosive mixture cannot enter the motor enclosure
 Ex-d (IEC 60079-1)	Zones 1-2	The enclosure is designed in such a way that an explosion inside the motor will not cause any deformation, and the enclosure will prevent the flame from propagating outside
 Ex-e (IEC 60079-7)	Zones 1-2	The motor is designed so that the temperature of the external and internal parts is always below the ignition temperature of the explosive mixture present in the surroundings. Moreover, the "T _e " time (locked rotor time), shall be at least 5 sec or longer depending on the starting current (see Temperature Classes)
 Ex-n (IEC 60079-15)	Zone 2	The motor is designed in such a way that, during normal operation, no sparks will occur and the temperature in any part is below the ignition temperature of the explosive mixture present in the surroundings (see Temperature Classes)

CE marking according to ATEX

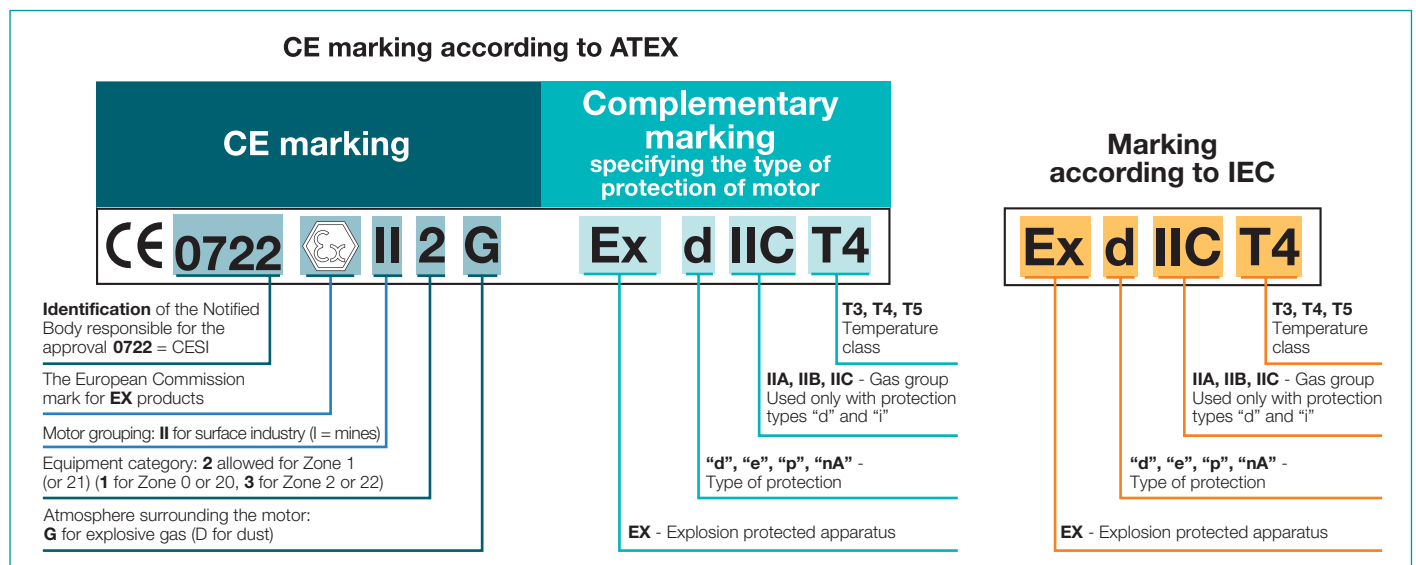

Ready to meet today's speed control demands



ABB high voltage flameproof motors can be used with variable speed drives without the need for a combined type test

ABB has designed an extensive portfolio of variable speed drives that is available through ABB's sales office and technical partners around the world.

To meet the varying requirements of its customers, ABB offers a wide range of drives that meet the specific demands of pump, fan, conveyor and compressor applications through to machinery and marine applications.

Benefits of using ABB drives

Being able to vary the speed and torque of an electric motor, and in turn the driven load by using an ABB drive, bring benefits including:

– Substantial energy savings

Rather than have an electric motor running continuously at full speed, an electric drive allows the user to slow down or speed up the motor depending on the demand.

– Optimal process control

An electric drive enables a process to achieve the right speed and torque while maintaining its accuracy. All of which contribute to a more consistent quality and throughput of the end product.

– Reduced need for maintenance

Being able to vary the speed and torque of an electric motor means there is less wear and tear on the motor and the driven machine. For example, the ability to bring a process up to speed slowly prevents the sudden shock loading that can damage a motor and the driven machine over time.

– Efficient system upgrade

An electric drive allows the removal of valves, gear and belts. It also ensures network dimensioning based on a lower starting current.

– Functional safety

Most ABB drives offer functional safety features that comply with the requirements of the European Union Machinery Directive 2006/42/EC. This directive is associated with standards like EN 62061 (IEC, defining SIL – Safety Integrity Level) and EN ISO 13849-1 (defining PL – Performance Level).

Life cycle services and support

From pre-purchase to migration and upgrades

ABB offers a complete portfolio of services to ensure trouble-free operation and long product lifetimes. These services cover the entire life cycle. Local support is provided through a global network of ABB service centers and certified partners.

Pre-purchase

ABB's front-end sales organization can help customers to quickly and efficiently select, configure and optimize the right *motor or generator* for their application.

Installation and commissioning

Professional installation and commissioning by ABB's certified engineers represent an investment in availability and reliability over the entire life cycle.

Engineering and consulting

ABB's experts provide energy efficiency and reliability appraisals, advanced condition and performance assessments and technical studies.

Condition monitoring and diagnosis

Unique services collect and analyze data to provide early warnings of problems before failures can occur. All critical areas of the equipment are covered.

Maintenance and field services

ABB offers life cycle management plans and preventive maintenance products. The recommended four-level maintenance program covers the entire product lifetime.

Spare parts

Spare parts and support are offered throughout the life cycle of ABB products. In addition to individual spares, tailored spare part packages are also available.

Repair and refurbishment

Support for all ABB *motors and generators* and other brands is provided by ABB's global service organization. Specialist teams can also deliver emergency support.

Migration and upgrades

Life cycle audits determine the optimum upgrades and migration paths. Upgrades range from individual components to direct replacement *motors and generators*.

Training

Product and service training courses take a practical approach. The training ranges from standard courses to specially tailored programs to suit customer requirements.

Specialized support

Specialized support is offered through ABB's global service organization. Local units provide major and minor repairs as well as overhauls and reconditioning.

Service contracts

Service contracts are tailored to the customer's needs. The contracts combine ABB's entire service portfolio and 120 years of experience to deploy the optimal service practices.

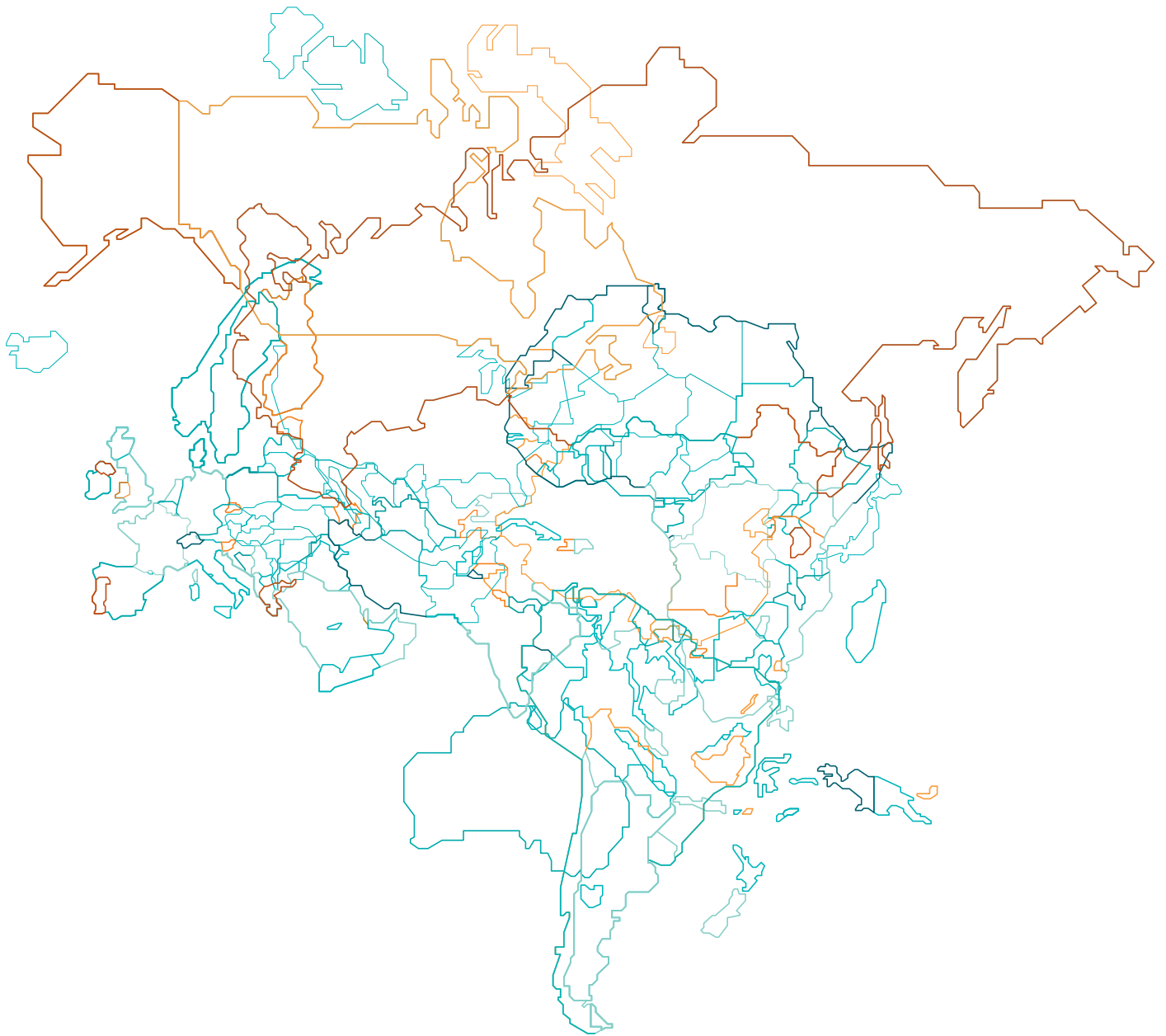

Contact us

www.abb.com/motors&generators

We reserve the right to make technical changes or modify the contents of this document without prior notice. With regard to purchase orders, the agreed particulars shall prevail. ABB Ltd. does not accept any responsibility whatsoever for potential errors or possible lack of information in this document.

We reserve all rights in this document and in the subject matter and illustrations contained herein. Any reproduction, disclosure to third parties or utilization of its contents – in whole or in parts – is forbidden without prior written consent of ABB Ltd.

© Copyright 2012 ABB. All rights reserved.

